

Low Cost Multi-Channel RF Transceiver Module

Product Description

The RC11XX-RC232 RF Transceiver Modules are compact surface-mounted high performance modules for FSK operation with embedded protocol. The modules are completely shielded and pre-certified for operation under the European radio regulations for license-free use.

Applications

- OEM equipment
- Radio modems
- Alarm and security systems
- Point-of-sales terminals
- Bar code scanners
- Telemetry stations
- Fleet management

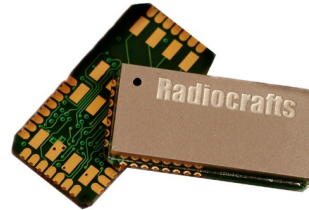

Features

- Very small module (12.7 x 25.4 x 3.5 mm)
- Very low sleep current consumption
- Embedded RC232™ protocol with Addressing and Error check
- 128 byte data buffer
- Two-wire UART interface for easy RS232/422/485 wire replacement (handshake optional)
- Compact shielded module for SMD mounting
- No external components
- No configuration required for single-channel use
- Easy to use data interface
- Wide supply voltage range, 2.0 – 3.6 V
- RC1140/80-RC232 conforms with EU R&TTE directive (EN 300 220, EN 301 489, EN 60950)
- RC1190-RC232 conforms with regulations for operation under FCC CFR 47 part 15

Quick Reference Data

Parameter	RC1140-RC232	RC1180-RC232	RC1190-RC232	Unit
Frequency bands	433.05 – 433.79	868.0 – 870.0	902 – 915	MHz
Number of channels	17	16	50	
Data rate	1.2 - 100	1.2 - 100	1.2 - 100	kbit/s
Max output power	9	9	-1	dBm
Sensitivity	-110	-110	-110	dBm
Supply voltage	2.0 – 3.6	2.0 – 3.6	2.0 – 3.6	Volt
Current consumption, RX / TX	24 / 35	24 / 37	24 / 37	mA
Current consumption, SLEEP	Typ. 0.3	Typ 0.3	Typ 0.3	uA
Temperature range	-40 to +85	-40 to +85	-40 to +85	°C

PRELIMINARY INFORMATION. Specifications and information herein are subject to change without notice.

Typical application circuit

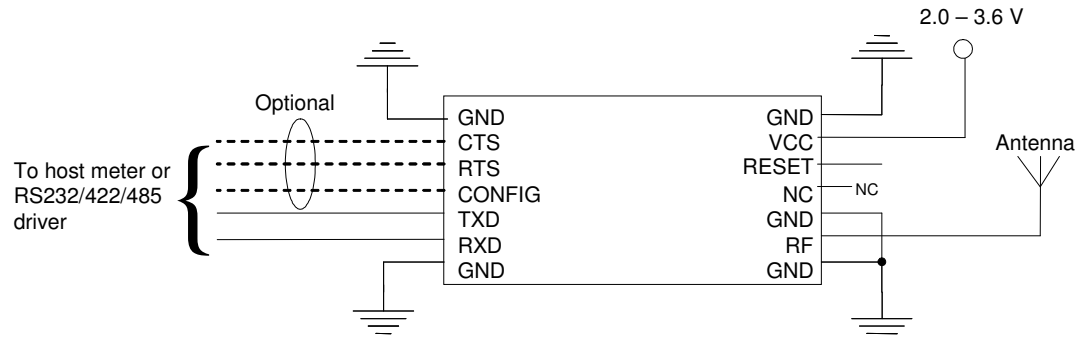

Quick Product Introduction

How do I transmit data?

Send your data to the RXD pin on the module. Use the UART format with settings (19200, 8, 1, N, no flow control). Up to 128 bytes are buffered in the module. The module will transmit the data when

- the max packet length is reached
- the unique end character is sent
- the modem timeout limit is reached

The packet length, end character and timeout limit are configurable in-circuit.

How do I receive data?

Any received data packet with correct address and check sum will be sent on the TXD pin using the same UART format as for transmit.

What about the antenna?

In most cases a simple quarter wavelength wire or a PCB track will do. Connect a piece of wire to the RF pin with length corresponding to the quarter of a wavelength. For space limited products, contact Radiocrafts and we will recommend the best antenna solution for your application.

How do I change the RF channel or any other parameter?

To change configurable parameters, assert the CONFIG pin, and send the command string using the same serial interface as for transmitting data. Parameters can be changed permanently and stored in non-volatile memory in the module.

RCTools

RCTools is a powerful and easy to use PC suite that helps you during test, development and deployment of the RC11XX-RC232. Visit www.radiocrafts.com for a free download and full documentation.

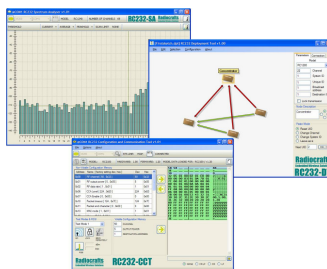

Pin Assignment

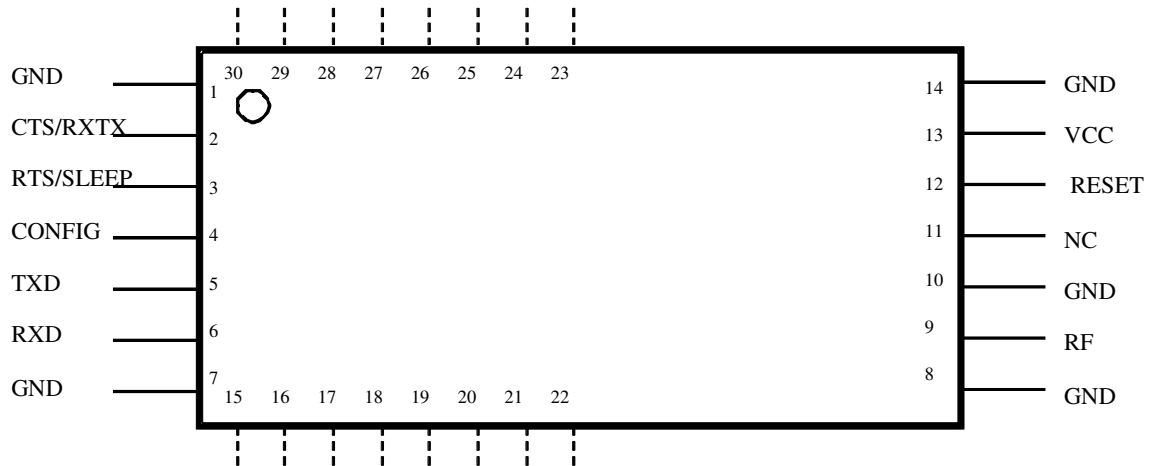

Pin Description

Pin no	Pin name	Description	Equivalent circuit
1	GND	System ground	
2	CTS/RXTX	UART Clear to Send or UART RXTX	<p>Input:</p> <p>Output:</p>
3	RTS/SLEEP	UART Request to Send. Set low to enter Sleep mode if RTS handshake is not in use.	
4	CONFIG	Configuration Enable. Active low. Should normally be set high.	
5	TXD	UART TX Data	
6	RXD	UART RX Data	
7	GND	System ground	
8	GND	System ground	

9	RF	RF I/O connection to antenna	
10	GND	System ground	
11	NC	Not connected	
12	RESET	Main reset (active low). Should normally be left open. Internal 12 kΩ pull-up resistor.	
13	VCC	Supply voltage input. Internally regulated.	
14	GND	System ground	
15-22	RESERVED	Test pins or pins reserved for future use. <i>Do not connect!</i>	
23-30	RESERVED	Test pins or pins reserved for future use. <i>Do not connect!</i>	

Note 1: For UART communication the TXD and RXD are used for serial data, and CTS and RTS for flow control (optional).

Note 2: The internal pull-ups on CONFIG and RTS/SLEEP pin are disabled in Sleep mode to minimise the sleep current.

Block Diagram

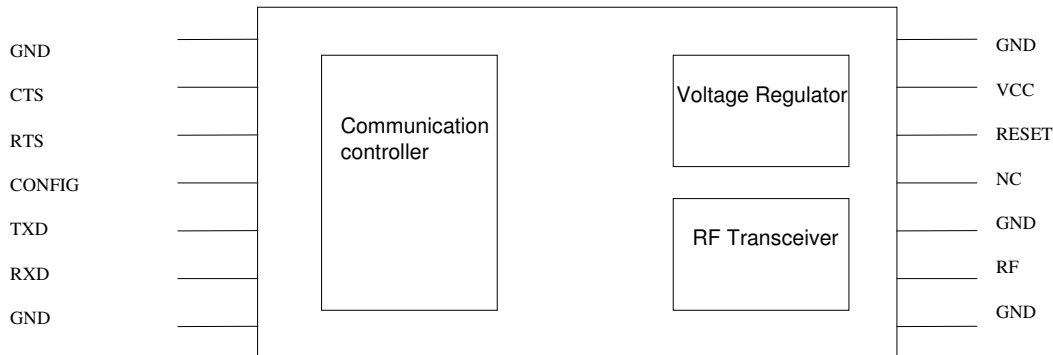

Circuit Description

The module contains a communication controller with embedded RC232™ protocol software, a high performance RF transceiver and an internal voltage regulator.

The communication controller handles the radio packet protocol, the UART interface and controls the RF transceiver. Data to be sent by the host is received at the RXD pin and buffered in the communication controller. The data packet is then assembled with preamble, start-of-frame delimiter (SOF), address information and CRC check sum before it is transmitted on RF. The preamble and SOF is always used. The address and CRC are optional.

The RF transceiver modulates the data to be transmitted on RF frequency, and demodulates data that are received.

Received data are checked for correct address and CRC by the communication controller. If the address matches the modules own address, and no CRC errors were detected, the data packet is sent to the host on the TXD line after removing the header.

The asynchronous UART interface consists of RXD and TXD. Optionally CTS, RTS can be used for hardware handshake flow control. RXTX can be used to control the direction of an RS485 driver circuit.

When the CONFIG pin is asserted the communication controller interprets data received on the RXD pin as configuration commands. There are commands to change the radio channel, the output power, the destination address etc. Permanent changes of the configuration is also possible and are then stored in internal non-volatile memory.

The RF protocol and the configuration commands are described in detail in the RC232™ User Manual.

The supply voltage is connected to the VCC pin. The module contains an internal voltage regulator and can therefore operate over a wide supply voltage range.

RC232™ Embedded Protocol

The module offers a buffered packet radio in the RC232™ embedded protocol. Using the buffered packet radio mode, all data to be sent is stored in the module before they are transmitted by the RF circuitry. Likewise, when data is received they are stored in the module before they are sent to the host. This allows the communication controller to add address information and to do error check of the data. In buffered mode the UART interface is used to communicate with the host.

The embedded protocol, configuration commands and configuration memory is described in the RC232™ User Manual. This protocol is used in a wide range of RF modules available from Radiocrafts. Please refer to the latest revision available on Radiocrafts web-site.

Power Management

The module can be set in SLEEP mode in order to reduce the power consumption.

The low power SLEEP mode is entered by using the SLEEP command in Configuration mode, or by pulling RTS/SLEEP pin low. In sleep mode the module will not receive or detect incoming data, neither from the host (UART port) nor from the RF transceiver. The module is awakened from the SLEEP mode by a positive edge on the CONFIG pins if the module was set in SLEEP mode using the 'Z' command. The module is awakened by a positive edge on the RTS/SLEEP pin if this pin were used to enter SLEEP mode. CONFIG must be high when awakening the module to avoid setting the module directly in configuration mode. UART data on RXD to the module should be avoided in sleep mode.

All configuration settings and RAM values are retained during Sleep. The pull-ups on RTS/SLEEP and CONFIG pin are disabled during sleep mode in order to minimise the sleep current consumption.

If the module is shut completely off, all configuration settings in non-volatile memory is restored, but values in RAM are overwritten with default settings.

Enter SLEEP Mode Using RTS/SLEEP pin

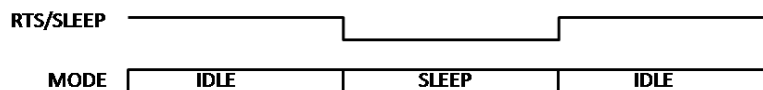

Enter SLEEP Mode Using CONFIG and Z Command

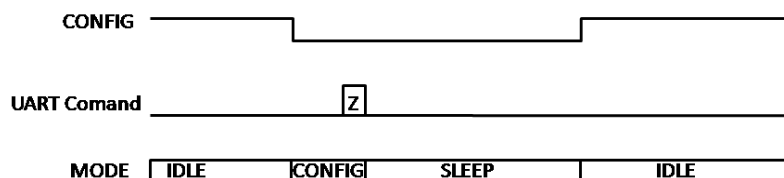

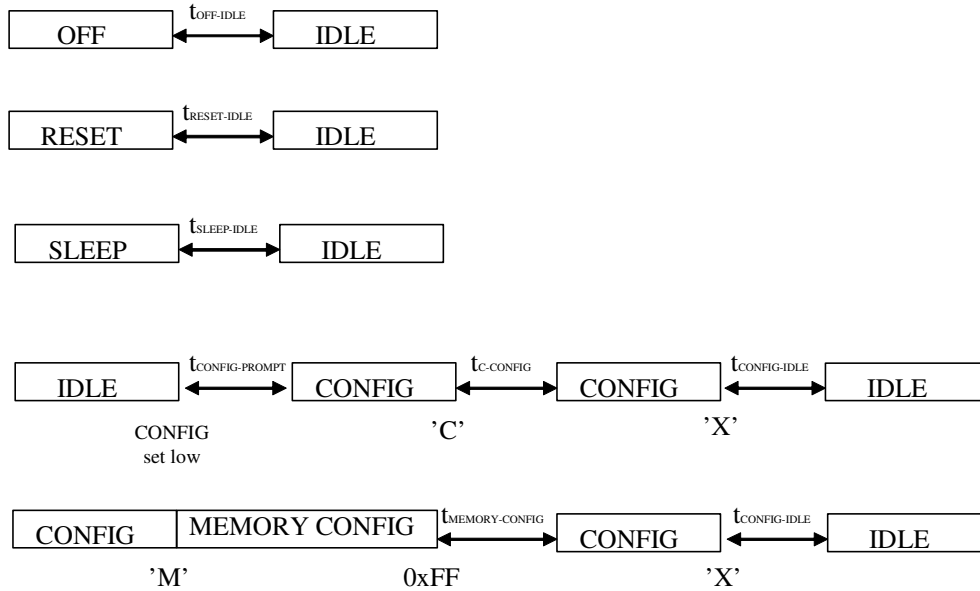

Symbol	Value	Description / Note
$t_{\text{RX-TXD}}$	180 us	Time from last byte is received from the air until first character is sent on the UART
t_{TXD}	Min 590 us	$t_{\text{TXD}} = \# \text{ bytes received} \times 590 \text{ us/char}$ (10 bits at 19.2 kBd + 70 us delay per character)
$t_{\text{TXD-IDLE}}$	900 us	Time from last character is sent on the UART until module is in IDLE mode (ready for RXD and RX)
$T_{\text{RXD-CTS}}$	20 us	Time from last character is received by the UART (including any timeout) until CTS is activated
$t_{\text{RXD-TX}}$	960 us	Time from last character is received by the UART (including any timeout) until the module sends the first byte on the air.
$T_{\text{TX-IDLE}}$	960 us	Time from last character is sent on the air until module is in IDLE mode (ready for RXD and RX)
$t_{\text{OFF-IDLE}}$	3.2 ms	
$t_{\text{RESET-IDLE}}$	3.0 ms	
$t_{\text{SLEEP-IDLE}}$	1.28 ms	
$t_{\text{CONFIG-PROMPT}}$	590 us	Time from CONFIG pin is set low until prompt (">")
$t_{\text{C\#-CONFIG}}$	1.1 ms	Delay after channel-byte is sent until prompt (">"). (For other commands like 'M', 'T' there is no delay but immediate prompt)
$t_{\text{MEMORY-CONFIG}}$	30.52 ms	In this period the internal flash is programmed. <i>Do not reset, turn the module off, or allow any power supply dips in this period as it may cause permanent error in the Flash configuration memory. After 0xFF the host should wait for the '>' prompt before any further action is done to ensure correct re-configuration.</i>
$T_{\text{CONFIG-IDLE}}$	1.42 ms	
t_{TX}	Min 26 ms	$t_{\text{TX}} = \# \text{ bytes to send} \times 1.24 \text{ ms/byte}$ (at 4.8 kbit/s) + 7 bytes preamble, sync and length + 2 bytes address + 2 bytes CRC

RF Frequency, Output Power Levels and Data Rates

The following table shows the available RF channels and their corresponding frequencies, nominal output power levels and available data rates.

Model	RF channel	Output power	Data rate
RC1140-RC232	1: 433.100 MHz	Channel 1-4:	1: 1.2 kbit/s
	2: 433.200 MHz	1: -20 dBm	2: 4.8 kbit/s
	3: 433.300 MHz	2: -10 dBm	3: 19.0 kbit/s
	4: 433.400 MHz	3: 0 dBm	4: 32.768 kbit/s
	5: 433.500 MHz	4: Not recommended*	5: 76.8 kbit/s
	6: 433.600 MHz	5: Not recommended*	6: 100 kbit/s
	7: 433.700 MHz	Channel 5-7:	7: For future use
	8: 433.800 MHz	1: -20 dBm	
	9: 433.900 MHz	2: -10 dBm	
	10: 434.000 MHz	3: 0 dBm	
	11: 434.100 MHz	4: 5 dBm	
	12: 434.200 MHz	5: Not recommended*	
	13: 434.300 MHz	Channel 8-17:	
	14: 434.400 MHz	1: -20 dBm	
	15: 434.500 MHz	2: -10 dBm	
	16: 434.600 MHz	3: 0 dBm	
	17: 434.700 MHz	4: 5 dBm	
	5: 9 dBm		
RC1180-RC232	1: 868.050 MHz	Channel 1-10:	1: 1.2 kbit/s
	2: 868.150 MHz	1: -20 dBm	2: 4.8 kbit/s
	3: 868.250 MHz	2: -10 dBm	3: 19.0 kbit/s
	4: 868.350 MHz	3: 0 dBm	4: 32.768 kbit/s
	5: 868.450 MHz	4: 5 dBm	5: 76.8 kbit/s
	6: 868.550 MHz	5: 9 dBm	6: 100 kbit/s
	7: 868.650 MHz	Channel 11-13:	7: For future use
	8: 868.750 MHz	1: -20 dBm	
	9: 868.850 MHz	2: -10 dBm	
	10: 868.950 MHz	3: 0 dBm	
	11: 869.050 MHz	4: 5 dBm	
	12: 869.150 MHz	5: Not recommended*	
	13: 869.525 MHz	Channel 14-16:	
	14: 869.750 MHz	1: -20 dBm	
	15: 869.850 MHz	2: -10 dBm	
	16: 869.950 MHz	3: 0 dBm	
	4: Not recommended*		
	5: Not recommended*		
RC1190-RC232	50 channels:	1: -20 dBm	1: 1.2 kbit/s
	902+nx0.5 MHz	2: -10 dBm	2: 4.8 kbit/s
	for n = [1, 50]	3: 0 dBm	3: 19.0 kbit/s
	default:	4: 5 dBm	4: 32.768 kbit/s
	1: 902.5 MHz	5: 9 dBm	5: 76.8 kbit/s
			6: 100 kbit/s
			7: For future use

* Not recommended due to spurious requirements

RF channel and output power level can be set using the configuration commands 'C' and 'P' respectively. The data rate can *only* be changed in configuration memory by using the 'M' command setting RF_DATA_RATE. The *default* RF channel and output power level can be set in

the configuration memory by using the 'M' command setting RF_CHANNEL and RF_POWER. The default values are used after power ON and RESET. The default factory settings are shown in **bold** in the table above.

For more details on changing the RF channel, output power or data rate, refer to the description of the configuration commands.

The use of RF frequencies, maximum allowed RF power and duty-cycles are limited by national regulations. The RC1180-RC232 and RC1140-RC232 is complying with the applicable directives within the European Union when used within these limitations.

RC1190-RC232 is pending approval under FCC for use in the US and Canada. For more information see section "Regulatory Compliance Information".

RSSI Reading

The module provides a digital Received Signal Strength Indicator (RSSI) through the 'S' command, or attached to received messages. The module returns an 8 bit character (one byte) indicating the current input signal strength (followed immediately by a second character which is the prompt '>') when in command mode). The signal strength can be used as an indication of fading margin, or as a carrier sense signal to avoid collisions.

The signal strength measure by the S command is the instantaneous value. The RSSI value appended to a received message (RSSI_MODE = 1) is the signal strength of that received packet.

The RSSI value increases with increased input signal strength in 0.5 dB steps. Input signal strength is given by (typ.):

$$P = - \text{RSSI} / 2 \text{ [dBm]}$$

Module Configuration

The configuration of the module can be changed in-circuit from the host during operation, at the time of installation of the equipment, at the manufacturing test, or even as a stand alone module. The configuration is changed sending commands on the UART interface after the module is set in configuration mode. The configuration mode is entered by asserting the CONFIG pin (set low).

In command mode the module will respond by sending a '>' prompt on the TXD pin. This indicates that the module is ready to receive commands. The CONFIG pin can then be de-asserted. Note that the CONFIG pin must be de-asserted *before* the Exit command ('X') is sent to the module in order to return to normal operation.

After a command is executed, the module responds with the '>' prompt character again indicating it is ready for a new command. Do not send a new command before the '>' prompt is received. The time required to execute a command can vary depending on the command (see the Timing Information section). There is no '>' prompt after the 'X' exit command.

The parameters that are set by commands directly take immediate effect after returning to normal operation (IDLE), but will not be stored in non-volatile memory, and will be lost in case the supply power is turned off or if the module is reset. These parameters are for example the radio channel and output power.

A list of commands is shown in the table below.

Parameter	Command	Argument in hex (decimal)	Note
Channel	'C' – 0x43	0x01-0x0C (1-12)	Data is stored in volatile memory only. For variants not listed here, refer to the specific data sheet.
Output power	'P' – 0x50	0x01-0x05 (1-5)	Data is stored in volatile memory only.
Signal Strength (RSSI)	'S' – 0x53	Returns one byte indicating the signal strength	
Memory configuration	'M' – 0x4D	(Address, Data): see list of parameters below. 0xFF exits memory configuration.	Used to enter memory configuration menu. Parameters changed are stored in non-volatile memory.
Exit command	'X' – 0x58	(none)	Exit to normal operation mode. All changes of parameters take effect.
Sleep mode	'Z' – 0x5A	(none)	CONFIG pin must be asserted while in SLEEP mode. Exit sleep mode by releasing CONFIG pin.
Test mode 0	'0' – 0x30	(none)	List all configuration memory parameters
Test mode 1	'1' – 0x31	(none)	TX carrier
Test mode 2	'2' – 0x32	(none)	TX modulated signal PN9 sequence
Test mode 3	'3' – 0x33	(none)	TX Off, RX mode

Note: ASCII characters are written as 'X', hexadecimal numbers are written like 0x00, and decimal numbers are written like 10 throughout the text. A table of ASCII characters and their respective hex and decimal values are found in the Appendix.

Commands must be sent as ASCII characters or their corresponding binary value. All arguments must be sent as binary values to the module (not as ASCII representation for hex or decimal). Any invalid command will be ignored and the '>' prompt will be re-sent. The CONFIG line must be de-asserted after the first '>' prompt was received, but before the 'X' command.

To make permanent changes to default values and other parameters, the Memory Configuration command 'M' is used. This command should be followed by pairs of byte being the memory address and the new value to be stored at that address. In order to exit the Memory Configuration mode command 'X' must be sent.

Example:

To select RF channel 3, send the follow sequence after asserting the CONFIG line and the '>' prompt is received:

Command	Hex	Response	Comment/Note
CONFIG asserted		'>'	De-assert CONFIG after '>' prompt
'C'	0x43	'>'	
3	0x03	'>'	Wait for '>' prompt
[A new command could be issued here]			
'X'	0x58	(none)	Module returns to IDLE state

It is important to enter Test mode 3 before exiting the configuration mode ('X') if Test mode 1 or 2 has been used. This will ensure proper operation in normal mode.

Configuration Memory

The table below shows the complete list of configurable parameters stored in non-volatile memory. These values can be changed using the 'M' command. All addresses and arguments must be sent as binary values to the module (not as ASCII representation for hex or decimal).

Parameter	Description	Address hex	Argument dec	Factory setting hex (dec)	Comment
Radio configuration					
RF_CHANNEL	Default RF channel	0x00	RC1140: 1-17 RC1180: 1-16 RC1190: 1-50	0x01 (1)	See table page 9 for details
RF_POWER	Default RF output power	0x01	1-5	0x05 (5)	See table page 9 for details
RF_DATA_RATE	Default RF data rate	0x02	1-7	0x03 (3)	See table page 9 for details
RSSI_MODE	Append RSSI	0x05	0-1	0x00 (0)	0: No RSSI append 1: RSSI append
Radio packet configuration					
PACKET_LENGTH	Max packet length.	0x0F	0x01-0x80 (1-128)	0x80 (128)	
PACKET_TIMEOUT	Time before modem time-out and transmitting the buffer	0x10	0x00-0xFE (0-254) 0x00 (0): None 0x01 (1): 32 ms 0x02 (2): 48 ms 0x03 (3): 64 ms 0x7C (124): 2 s 0xF9 (249): 4 s	0x7C (124)	None means packet timeout is disabled (not 0 s). Timeout value is (PACKET_TIMEOUT x 16 ms) + 0/16 ms min/max 0xFE (254) is max, giving 4.080 sec. Default is 2 s = 0x7C (124)
PACKET_END_CHARACTER		0x11	0x00: Off 0x01-0xFF: On	0x00	0: No end character 1-255: Use value as end character
Medium access, addressing and network management					
ADDRESS_MODE		0x14		0x02 (2)	0: No addressing 2: Use addressing
CRC_MODE		0x15		0x02 (2)	0: None 2: CRC16
UNIQUE_ID (UID)		0x19	0-255	0x01 (1)	
SYSTEM_ID (SID)		0x1A	0-255	0x01 (0)	
DESTINATION_ID (DID)		0x21	0-255	0x01 (1)	
BROADCAST_ADDRESS		0x28	0-255	0xFF (255)	
Data and configuration interface, UART Serial Port					
UART_BAUD_RATE	Baud rate	0x30	0x00: Not used 0x01: 2400 0x02: 4800 0x03: 9600 0x04: 14400 0x05: 19200 0x06: 28800 0x07: 38400 0x08: 56700 0x09: 76800 0x0A: 115200 0x0B: 230400	0x05 (5)	BE CAREFUL IF CHANGING AS HOST MAY LOOSE CONTACT WITH MODULE! Does not take effect until module is re-booted / reset.
UART_FLOW_CTRL	UART flow control	0x35	0: None 1: CTS only 3: CTS/RTS 4: RXTX(RS485)	0x00 (0)	

Note: Address location not listed should not be changed from the default value.

Antenna Connection

The antenna should be connected to the RF pin. The RF pin is matched to 50 Ohm. If the antenna connector is placed away from the module at the motherboard, the track between the RF pin and the connector should be a 50 Ohm transmission line.

On a two layer board made of FR4 the width of a microstrip transmission line should be 1.8 times the thickness of the board, assuming a dielectric constant of 4.8. The line should be run at the top of the board, and the bottom side should be a ground plane.

Example: For a 1.6 mm thick FR4 board, the width of the trace on the top side should be $1.8 \times 1.6 \text{ mm} = 2.88 \text{ mm}$.

The simplest antenna to use is the quarter wave whip antenna. A quarter wave whip antenna above a ground plane yields 37 Ohm impedance and a matching circuit for 50 Ohm are usually not required.

A PCB antenna can be made as a copper track where the ground plane is removed on the back side. The rest of the PCB board should have a ground plane as large as possible, preferably as large as the antenna itself, to make it act as a counterweight to the antenna. If the track is shorter than a quarter of a wavelength, the antenna should be matched to 50 ohms.

The lengths of a quarter wave antenna for different operational frequencies are given in the table below.

Frequency [MHz]	Length [cm]
433	16.4
868	8.2
915	7.8

PCB Layout Recommendations

The recommended layout pads for the module are shown in the figure below. All dimensions are in thousands of an inch (mil). The circle in upper left corner is an orientation mark only, and should not be a part of the copper pattern.

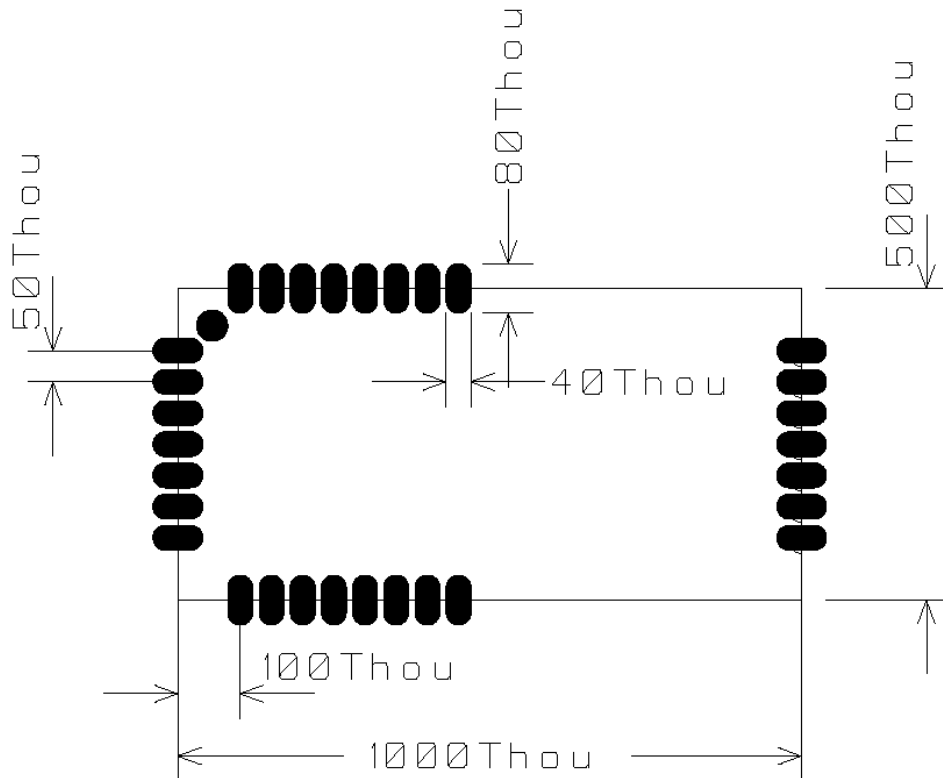

A PCB with two or more layers and with a solid ground plane in one of the inner- or bottom layer(s) is recommended. All GND-pins of the module shall be connected to this ground plane with vias with shortest possible routing, one via per GND-pin.

On the back side of the module there are several test pads. These test pads shall not be connected, and the area underneath the module should be covered with solder resist. If any routing or vias is required under the module, the routing and vias must be covered with solder resist to prevent short circuiting of the test pads. It is recommended that vias are tented.

Reserved pins should be soldered to the pads but the pads must be left floating.

Mechanical Drawing

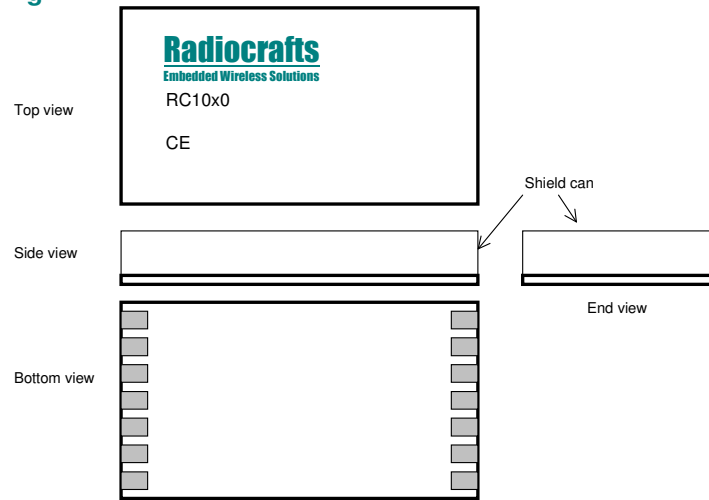

Mechanical Dimensions

The module size is 12.7 x 25.4 x 3.3 mm.

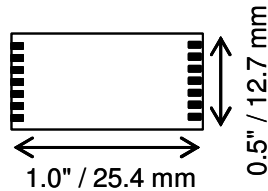

Carrier Tape and Reel Specification

Carrier tape and reel is in accordance with EIA Specification 481.

Tape width	Component pitch	Hole pitch	Reel diameter	Units per reel
44 mm	16 mm	4 mm	13"	Max 1000

Soldering Profile Recommendation

JEDEC standard IEC/JEDEC J-STD-020B (page 11 and 12), Pb-Free Assembly is recommended.

The standard requires that the heat dissipated in the "surroundings" on the PCB is taken into account. The peak temperature should be adjusted so that it is within the window specified in the standard for the actual motherboard.

Absolute Maximum Ratings

Parameter	Min	Max	Unit
Supply voltage, VCC	-0.3	3.9	V
Voltage on any pin	-0.3	3.9	V
Input RF level		10	dBm
Storage temperature	-50	150	°C
Operating temperature	-40	85	°C

Caution ! ESD sensitive device.
 Precaution should be used when handling the device in order to prevent permanent damage.

Under no circumstances the absolute maximum ratings given above should be violated. Stress exceeding one or more of the limiting values may cause permanent damage to the device.

Electrical Specifications

T=25°C, VCC = 3.0V if nothing else stated.

Parameter	Min	Typ.	Max	Unit	Condition / Note
Operating frequency RC1140 RC1180 RC1190	433.05 868.0 902.0		434.79 870.0 928.0	MHz	
Number of channels RC1140 RC1180 RC1190		17 16 50			
Input/output impedance		50		Ohm	
Data rate		1.2 4.8 19.2 32.768 76.8 100		kbit/s	
Frequency stability			+/-40	ppm	Including 10 years of aging.
Frequency stability aging			1	ppm/year	Starting after 10 years
Transmit power	-20		9	dBm	
FSK deviation	5.2		127	kHz	Depends on data rate
Channel Filter bandwidth	58		540	kHz	Depends on data rate
Spurious emission, TX < 1 GHz > 1 GHz 47 – 74 MHz 87.5 – 118 MHz 174 – 230 MHz 470 – 862 MHz			-36 -30 -54 -54 -54 -54	dBm	
Sensitivity 1.2 kbit/s 4.8 kbit/s 19.2 kbit/s 32.768 kbit/s 76.8 kbit/s 100 kbit/s		-110 -108 -105 -106 -103 -101		dBm	
Adjacent channel rejection		29		dB	
Alternate channel selectivity		53		dB	
Image channel rejection		28		dB	

Blocking / Interferer rejection / desensitization +/- 1 MHz +/- 2 MHz +/- 5 MHz +/- 10 MHz	30 35 50 60	43 49 68 72		dB	Wanted signal 3 dB above sensitivity level, CW interferer. Minimum numbers corresponds to class 2 receiver requirements in EN300220.
Saturation		-14		dBm	
Input IP3		TBD		dBm	
Spurious emission, RX			-57	dBm	
Supply voltage	2.0		3.6	V	
Current consumption, RX/IDLE		24		mA	Apply over entire supply voltage range
RC1140 TX Current consumption, TX -20 dBm -10 dBm 0 dBm 5 dBm 9 dBm		18 20 22 25 35		mA	Apply over entire supply voltage range
RC1180/1190 TX Current consumption, TX -20 dBm -10 dBm 0 dBm 5 dBm 9 dBm		16 17 22 30 37		mA	
Current consumption, SLEEP		0.3	1.0	uA	
Digital I/O Input logic level, low Input logic level, high Output logic level, low (1µA) Output logic level, high(-1µA)	70 % 0 TBD		30 % TBD VCC	V	Of VCC Of VCC
RESET pin Input logic level, low Input logic level, high	70 %		30 %	V	Minimum 250 ns pulse width
UART Baud Rate tolerance		+/- 2		%	UART receiver and transmitter
Configuration memory write cycles	1000				The guaranteed number of write cycles using the 'M' command is limited

Regulatory Compliance Information

The use of RF frequencies and maximum allowed RF power is limited by national regulations. The RC1140-RC232 and RC1180-RC232 has been designed to comply with the R&TTE directive 1999/5/EC. According to R&TTE directives, it is the responsibility of Radiocrafts' customers (i.e. RC11XX-RC232 end user) to check that the host product (i.e. final product) is compliant with R&TTE essential requirements. The use of a CE marked radio module can avoid re-certification of the final product, provided that the end user respects the recommendations given by Radiocrafts. A Declaration of Conformity is available from Radiocrafts on request.

The RC1190-RC232 has been tested towards FCC regulations for license free operation under part 15. However, a final approval is required by FCC for the end product.

The relevant regulations are subject to change. Radiocrafts AS do not take responsibility for the validity and accuracy of the understanding of the regulations referred above. Radiocrafts only guarantee that this product meets the specifications in this document. Radiocrafts is exempt from any responsibilities related to regulatory compliance.

Power Supply

Noisy external circuitry may under certain scenarios affect the transmitted signal on RC11XX-RC232 and precaution should be taken for EU R&TTE conformity. Example of circuits that can generate noise on the RC11XX-RC232 transmitted spectrum may be DC/DC converters and some level converters like RS232 and RS485. To increase spectrum margin it is important to add an EMI filter bead on the VCC pin of the RC11XX-RC232 module. Alternatively the RC11XX-RC232 may be powered from a separate voltage regulator. This will ensure that potential switching noise is filtered out from the power supply to the RC11XX-RC232. A block diagram of a typical PC serial port interface is illustrated below.

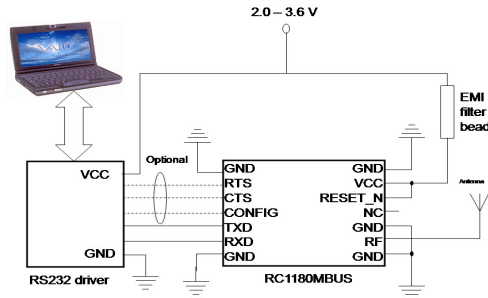

Suggested part numbers:

Component	Manufacturer	Part number
EMI filter bead	Murata	BLM11A102S, ordering code BLM18xx102xN1D

Programming Interface

For future firmware updates and possible custom variants it is recommended to include a 2x5 pins programming connector to the module programming pins. The connector should be a 2.54 mm pitch pin-row (same pitch in both directions), SMD or through-hole version, with the following connections:

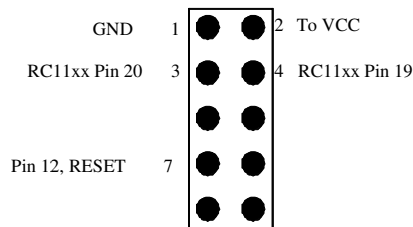

Reset connection

To minimize effect of noise on the Reset-line, the Reset pin on the module (pin 12) must be connected to external circuitry via an RC-network.

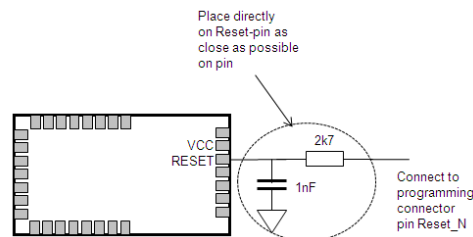

Appendix: ASCII Table

HEX	DEC	CHR	CTRL
0	0	NUL	^@
1	1	SOH	^A
2	2	STX	^B
3	3	ETX	^C
4	4	EOT	^D
5	5	ENQ	^E
6	6	ACK	^F
7	7	BEL	^G
8	8	BS	^H
9	9	HT	^I
0A	10	LF	^J
0B	11	VT	^K
0C	12	FF	^L
0D	13	CR	^M
0E	14	SO	^N
0F	15	SI	^O
10	16	DLE	^P
11	17	DC1	^Q
12	18	DC2	^R
13	19	DC3	^S
14	20	DC4	^T
15	21	NAK	^U
16	22	SYN	^V
17	23	ETB	^W
18	24	CAN	^X
19	25	EM	^Y
1A	26	SUB	^Z
1B	27	ESC	
1C	28	FS	
1D	29	GS	
1E	30	RS	
1F	31	US	
20	32	SP	
21	33	!	
22	34	"	
23	35	#	
24	36	\$	
25	37	%	
26	38	&	
27	39	'	
28	40	(
29	41)	
2A	42	*	
2B	43	+	
2C	44	,	
2D	45	-	
2E	46	.	
2F	47	/	
30	48	0	
31	49	1	
32	50	2	
33	51	3	
34	52	4	
35	53	5	
36	54	6	
37	55	7	
38	56	8	
39	57	9	
3A	58	:	
3B	59	;	
3C	60	<	
3D	61	=	
3E	62	>	
3F	63	?	

HEX	DEC	CHR
40	64	@
41	65	A
42	66	B
43	67	C
44	68	D
45	69	E
46	70	F
47	71	G
48	72	H
49	73	I
4A	74	J
4B	75	K
4C	76	L
4D	77	M
4E	78	N
4F	79	O
50	80	P
51	81	Q
52	82	R
53	83	S
54	84	T
55	85	U
56	86	V
57	87	W
58	88	X
59	89	Y
5A	90	Z
5B	91	[
5C	92	\
5D	93]
5E	94	^
5F	95	_
60	96	`
61	97	a
62	98	b
63	99	c
64	100	d
65	101	e
66	102	f
67	103	g
68	104	h
69	105	i
6A	106	j
6B	107	k
6C	108	l
6D	109	m
6E	110	n
6F	111	o
70	112	p
71	113	q
72	114	r
73	115	s
74	116	t
75	117	u
76	118	v
77	119	w
78	120	x
79	121	y
7A	122	z
7B	123	{
7C	124	
7D	125	}
7E	126	~
7F	127	DEL

Document Revision History

Document Revision	Changes
1.0	First release
1.1	Pull-up description during sleep and additional info regarding channel selection is added.
1.2	Updated timing table, Reset connection.
1.21	Minor correction

Product Status and Definitions

Current Status	Data Sheet Identification	Product Status	Definition
	Advance Information	Planned or under development	This data sheet contains the design specifications for product development. Specifications may change in any manner without notice.
X	Preliminary	Engineering Samples and First Production	This data sheet contains preliminary data, and supplementary data will be published at a later date. Radiocrafts reserves the right to make changes at any time without notice in order to improve design and supply the best possible product.
	No Identification Noted	Full Production	This data sheet contains final specifications. Radiocrafts reserves the right to make changes at any time without notice in order to improve design and supply the best possible product.
	Obsolete	Not in Production	This data sheet contains specifications on a product that has been discontinued by Radiocrafts. The data sheet is printed for reference information only.

Disclaimer

Radiocrafts AS believes the information contained herein is correct and accurate at the time of this printing. However, Radiocrafts AS reserves the right to make changes to this product without notice. Radiocrafts AS does not assume any responsibility for the use of the described product; neither does it convey any license under its patent rights, or the rights of others. The latest updates are available at the Radiocrafts website or by contacting Radiocrafts directly.

As far as possible, major changes of product specifications and functionality, will be stated in product specific Errata Notes published at the Radiocrafts website. Customers are encouraged to check regularly for the most recent updates on products and support tools.

Trademarks

RC232™ is a trademark of Radiocrafts AS. The RC232™ Embedded RF Protocol is used in a range of products from Radiocrafts. The protocol handles host communication, data buffering, error check, addressing and broadcasting. It supports point-to-point, point-to-multipoint and peer-to-peer network topologies.

All other trademarks, registered trademarks and product names are the sole property of their respective owners.

Life Support Policy

This Radiocrafts product is not designed for use in life support appliances, devices, or other systems where malfunction can reasonably be expected to result in significant personal injury to the user, or as a critical component in any life support device or system whose failure to perform can be reasonably expected to cause the failure of the life support device or system, or to affect its safety or effectiveness. Radiocrafts AS customers using or selling these products for use in such applications do so at their own risk and agree to fully indemnify Radiocrafts AS for any damages resulting from any improper use or sale.

© 2008, Radiocrafts AS. All rights reserved.

Contact Information

Web site: www.radiocrafts.com

Address:

Radiocrafts AS
Sandakerveien 64
NO-0484 OSLO
NORWAY

Tel: +47 4000 5195

Fax: +47 22 71 29 15

E-mail: radiocrafts@radiocrafts.com
sales@radiocrafts.com
support@radiocrafts.com